

Flexible Sprinkler Hose

Installation for suspended ceiling systems of ASTM C635 ceiling systems in accordance with ASTM C636 standards

INSTALLATION INSTRUCTIONS

- RASCOFLEX flexible sprinkler systems products must be installed according to National Fire Protection Association such as NFPA 13, 13D and 13R standards. The intended use of RASCOFLEX flexible sprinkler systems products are in wet, dry, or preaction systems as permitted by applicable standards.
- Any alterations or modifications to RASCOFLEX flexible sprinkler systems products will void RASCOFLEX warranty.
- In addition, installations must comply with codes, rules, and regulations of local authority having jurisdiction as applicable.
- RASCOFLEX flexible sprinkler systems products such as flexible sprinkler hose and its accessories must not be used in combination with the products of other manufacturers.
- Suspension ceiling construction must meet the requirements of ASTM C635 and install in accordance with ASTM C636 standard.
- According to NFPA requirements, flush the system to eliminate any foreign objects and materials until water runs clear.
- Short 90° Elbow reducers are typically used with Concealed Sprinklers (FM & VdS Only).
- The flexible hose should not be bent or manipulated up-and-down or side-to-side when pressurized.
- Do NOT install RASCOFLEX flexible drops without bends. Follow the guidelines of respective minimum bend radii and number of allowable bends shown on "Friction Loss Data" chart.
- Do NOT attach flexible sprinkler system to domestic hot water systems and do NOT install the sprinkler system products in an environment where the maximum ambient temperature can exceed 300°F (149°C). DO NOT install on wet system if system is subject to temperatures below 32°F (0°C).
- If user installs the flexible sprinkler system at the environment of cold weather, protect wet piping system from freezing temperatures.
- The owner is responsible and liable for maintaining the fire protection system under the guidance of local authority as well as NFPA standards to maintain the proper operating condition.
- For minimum maintenance and inspection requirements, refer to NFPA 25 and other relevant NFPA standards that define the care and maintenance of sprinkler systems.



Warning

Relocation of RASCOFLEX flexible sprinkler system must be performed by certified or qualified installer familiar with the original design criteria of systems, sprinkler approvals, National Fire Protection Association standards, and state and local fire codes.

Failure to relocate the product properly could affect the performance during a fire and cause serious personal injury, and/or property damage.

TECHNICAL DATA – FLEXIBLE SPRINKLER HOSE



Warning

The effect of chemical composition, pH level and balance, operating temperature and related material environment, chloride and oxygen level, flow rate, conformance of intended use and service, and life cycle of products on the flexible hose must be evaluated and inspected by the qualified material handler.

The verification of conformity of using stainless steel flexible hose systems with the intended fluid media within the fire protection piping system is a sole responsibility of system designer.

Listing and Approvals

- Factory Mutual, FM Class No. 1637
- Underwriter's Laboratories, Inc., UL 2443

Maximum Working Pressure

- 200 psi (14 bar) - FM Approved
- 175 psi (12 bar) - UL Listed

Maximum Ambient Temperature

300°F (149°C)

Minimum Bend Radius of Flexible Hose

- 3" (76mm) - UL Listed
- 7" (178mm) - FM Approved



Maximum Sprinkler K-Factor (to be Connected to Sprinkler Reducer, Outlet)

- 5.6 US (80 metric) – 1/2" (15mm)
- 14.0 US (200 metric) – 3/4" (20mm)
- UL Listed and FM Approved

Maximum Number of 90° Bends

Refer to the "Friction Loss Chart" on Spec Sheet

Connection to Branch Line of Piping System

1" (25mm) NPT/BSPT

Flexible Hose Bend Characteristics

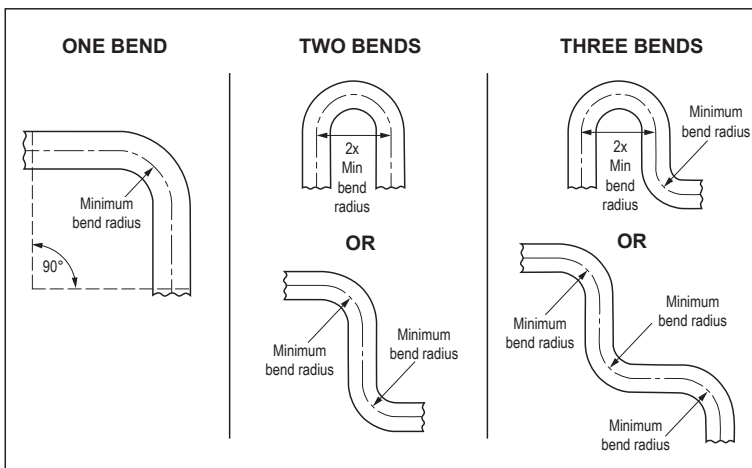

WARNING: Failure to follow the instructions could affect the performance of flexible sprinkler system during a fire and result in serious personal injury and/or property damage.

INSTALLATION INSTRUCTIONS OF SUSPENDED CEILING OF T-BAR GRIDS

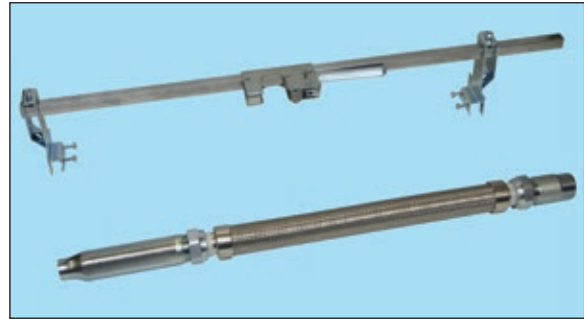

1. Visually inspect the RASCOFLEX sprinkler drop components including Bracket Assembly and Flexible Sprinkler Hose Assembly for any sign of physical damage.



2. Remove Inlet Nipple and Outlet Reducer from the Flexible Hose and inspect the Sealing Gaskets including O-Ring and Insulation Ring to see if they are in place properly and show no signs of damage. Connect Outlet Reducer back to the Nut of Flexible Hose by using pipe wrench. The torque specification should be approximately 44ft/lbs, approximately 1/2 to 3/4 turn past hand tight.



3. Apply PTFE tape or thread sealant to the thread of Inlet Nipple in accordance with the PTFE tape or thread sealant manufacturer's instruction and NFPA 13 guidelines. Use a pipe wrench to install the Inlet Nipple to the branch line as seen on above picture. The Torque Range should be approximately 44 ft/lbs, approximately 1/2 to 3/4 turn past hand tight. **Apply torque only to the Nut and Do NOT surpass the recommended torque.**



4. Install Outlet Nipple to the Nut of the Flexible Hose by using a pipe wrench. The torque range should be approximately 44 ft/lbs, approximately 1/2 to 3/4 turn past hand tight.

WARNING: DO NOT apply PTFE tape or thread sealant to the thread of the Outlet Nipple to connect it to the Flexible Hose.



5. Place the fully assembled Bracket Assembly to the desired location in the ceiling grid.

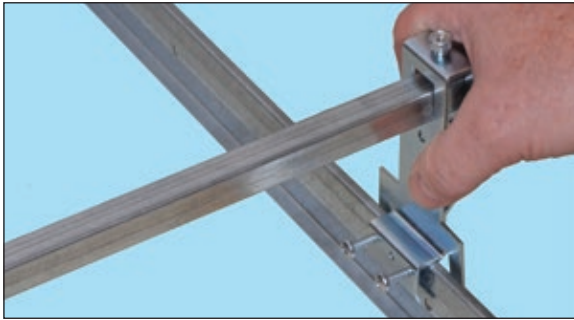

6. If you need to adjust the bracket width, the hex nut on top of the side bracket can be loosened to slide the side bracket on the bar stock to adjust the side bracket within the designated width of T-Bar grid. Tighten the hex nut on top of the side bracket to a torque of 2.89 ft/lbs to secure the side bracket to the bar stock.



7. Once the Bracket Assembly is properly positioned, hold bracket in place and secure bracket to T-Bar grid using a screw driver and enclosed screw and bolt. Tighten the bolt first with a torque of 2.24 ft/lbs and tighten the screw bracket is fully secured.

Note: DO NOT over-tighten screws as it will cause the screw to strip resulting in an unsecured bracket connection.



8. When both side brackets are securely attached onto the grid, open the Center Bracket gate and insert the Reducer portion of Flexible Hose to the gate. Adjust height of Reducer to desired position. For center of tile installations, position the center bracket between the two indentation marks on the bar stock as shown above.

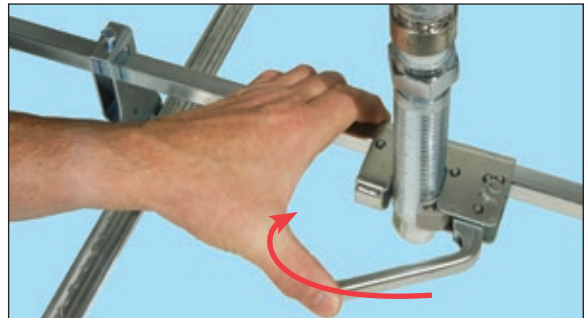

9. After adjusting the height of the Reducer, close the Center Bracket by closing the handle from right to left as seen in the picture. While doing so, use other hand to hold the bar stock to minimize the movement caused by closing the handle. Make sure the gate of Center Bracket is firmly closed.

WARNING: Improper closure of gate of Center Bracket may cause damage to the property and serious injury to the person(s).

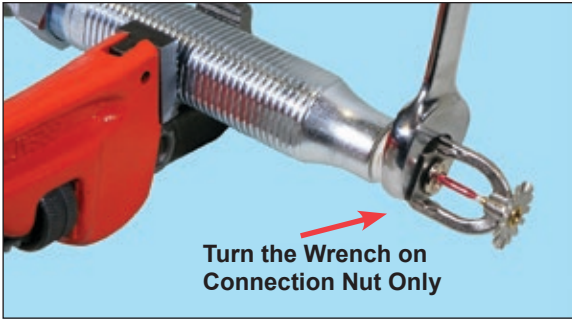

10. Apply PTFE tape to the Thread of the Sprinkler Head and connect Head with Reducer of the Flexible Hose. (Refer to the NFPA guidelines and Sprinkler Head manufacturer's installation instructions for proper installation).

HOW TO OPEN THE CENTER GATE BRACKET ONCE IT IS LATCHED



1. Look for the Ring-Shaped Wire Hook located at the top right corner of the Center Bracket

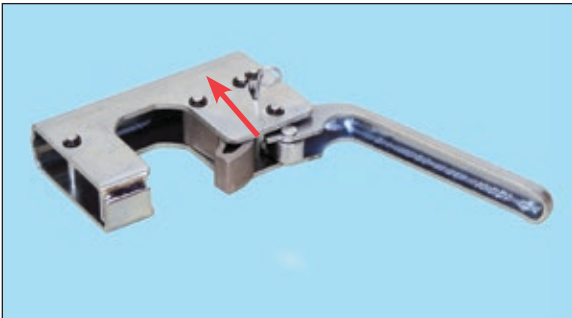

2. While grabbing the handle, push the Ring-Shaped Wire Hook towards back of Center Bracket to release the handle from locking mode. When pressing the Wire Hook, make sure to hold on to the Bar Stock to minimize the movement of Bracket.



3. Pull the handle towards the installer to open the Gate of Center Bracket.

WARNING: Unless the operator pushes the Ring Shaped Wire Hook, the handle will not open. The excessive pressure or force on the Wire Hook by operator will damage the Wire Hook and as a result, the handle will be inoperable.

INSTALLATION INSTRUCTIONS OF 2 X 4 METAL STUD CEILING GRIDS (FM ONLY)

1. Perform steps 1 – 4 of the "Installation Instructions of Suspended Ceiling of T-Bar Grids" (see page 2).

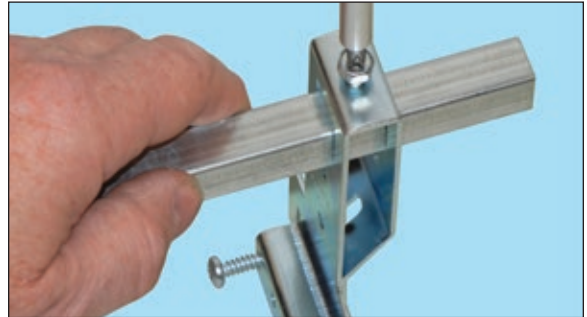

2. Loosen the bolt from top of one side of side bracket assembly using a screw driver.

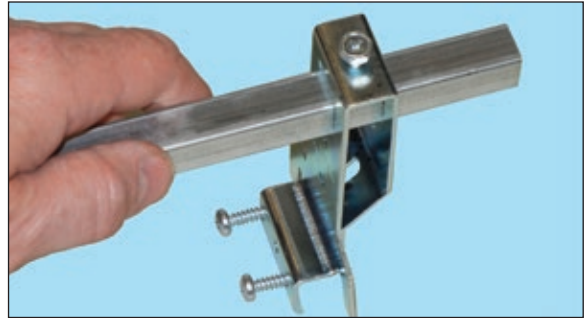

3. Remove from bar stock and turn the side bracket (side with the bolt removed at step 2) the other way around. Re-insert the disassembled side bracket to bar stock.

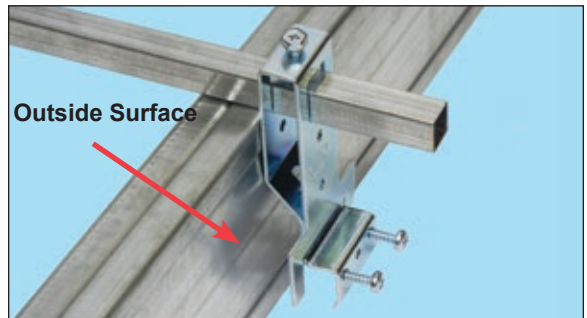

4. Place the side bracket against the outside surface of the metal stud ceiling grid and have the bar stock rest on the top of grid.

- Adjust the disassembled side bracket to the outside flat surface of the opposite metal stud grid.

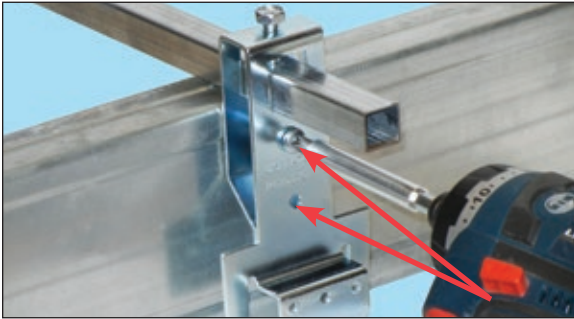

- Once in place, secure the bracket assembly to the metal stud ceiling grid by using four (4), 2" long #8 self-drilling sheet metal screws through the holes provided on each side of bracket. On each side of side brackets, there are two (2) holes for self-drilling sheet metal screws as shown above. Make sure to use both holes to secure the side brackets firmly. Ensure that the sheet metal screws penetrate the metal stud ceiling grid.

NOTE: Fix the top two (2) sheet metal screws first.

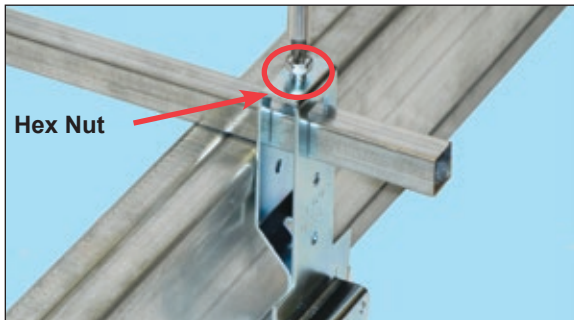

- Tighten the hex nut on top of the side bracket with a torque of 2.89 ft/lbs.

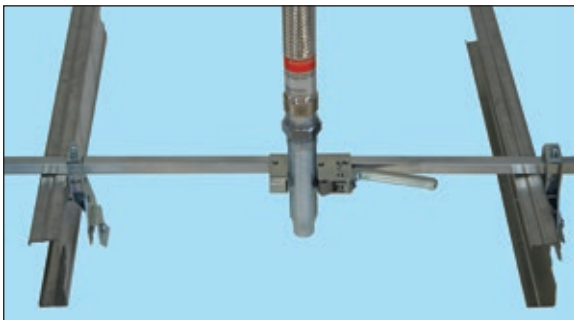

- Position the center bracket to the desired location.

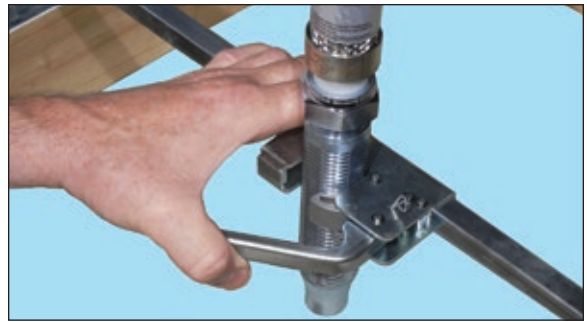

- Place the outlet reducer into the center bracket, then adjust the height of the outlet reducer to the desired level and lock the reducer into place by closing the handle on the center bracket firmly until you hear the click sound. While doing so, use other hand to hold the bar stock to minimize the movement caused by closing the handle.

NOTE: For metal studs larger than 2 x 4, longer sprinkler reducing nipples should be used or the alternative installation method below should be used.

ALTERNATIVE METAL STUD INSTALLATION INSTRUCTIONS (FM ONLY)

- Perform steps 1 – 4 of the "Installation Instructions of Suspended Ceiling of T-Bar Grids" (see page 2).
- Loosen the bolt from top of one side of side bracket assembly.
- Measure the distance between the metal studs.
- If the bar stock is longer than the distance between the two (2) metal studs, cut the bar stock to the length where it fits between the two (2) metal studs. The length must be measured from the inside of metal stud where the side bracket and the bar stock connected will rub against the surface of metal stud to the opposite surface of metal stud where the other side of side bracket and bar stock joint will rub against the surface of metal stud.

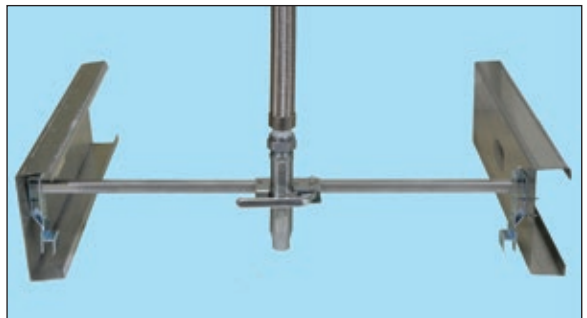

- Once in place, secure the bracket assembly to the metal stud ceiling grid by using four (4), 2" long #8 self-drilling sheet metal screws through the holes provided on each side of bracket. On each side of

side brackets, there are two (2) holes for self-drilling sheet metal screws as shown above. Make sure to use both holes to secure the side brackets firmly. Ensure that the sheet metal screws penetrated through the metal stud ceiling grid.

NOTE: Fix the top two (2) sheet metal screws first.

6. Tighten the bolt on top of the side bracket with a torque of 2.89 ft/lbs.
7. Position the center bracket to the desired location.
8. Place the outlet reducer into the center bracket, then adjust the height of the outlet reducer to the desired level and lock the reducer into place by closing the handle on the center bracket firmly until you hear click sound. While doing so, use other hand to hold the bar stock to minimize the movement caused by closing the handle.

INSTALLATION INSTRUCTIONS OF 2 X 4 WOOD BEAM CEILING GRIDS

1. Perform steps 1 – 4 of the “Installation Instructions of Suspended Ceiling of T-Bar Grids” (see page 2).

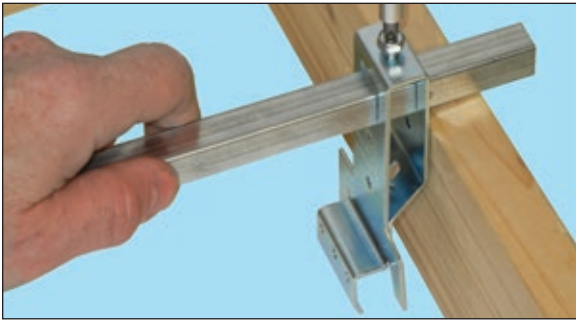

2. Loosen the bolt from top of one side of side bracket assembly.
3. Place the side bracket without the hex nut connected to the bar stock against the inside surface of the wood beam ceiling grid.

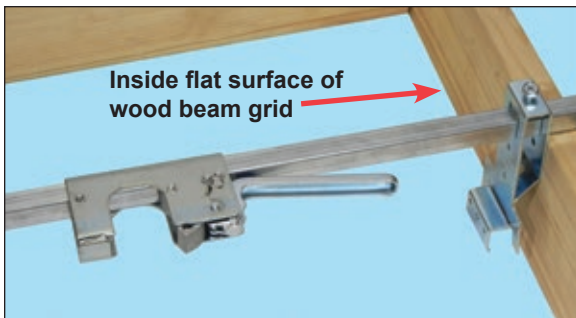

4. Adjust the disassembled side bracket (with hex nut) to the inside flat surface of the opposite wood beam grid as shown in the picture above.

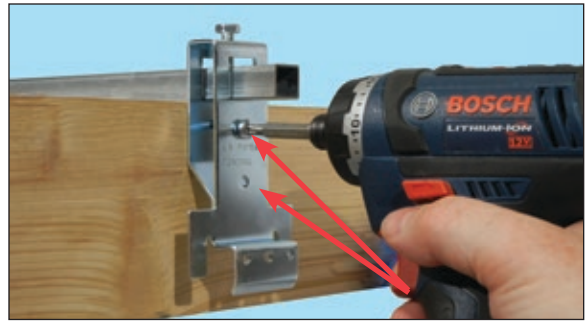

5. Once in place, secure the bracket assembly to the wood beam ceiling grid by using four (4), #8 x 2" ~ 3" wood screws through the holes provided on each side of bracket. On each side of the side brackets, there are two (2) holes for self-drilling sheet metal screws as shown above. Make sure to use both holes to secure the side brackets firmly. Ensure that the wood screws penetrate the wood beam ceiling grid until side bracket is securely in place.

NOTE: Fix the top two (2) wood screws first.

6. Tighten the bolt on top of the side bracket with a torque of 2.89 ft/lbs.



7. Position the center bracket to the desired location.

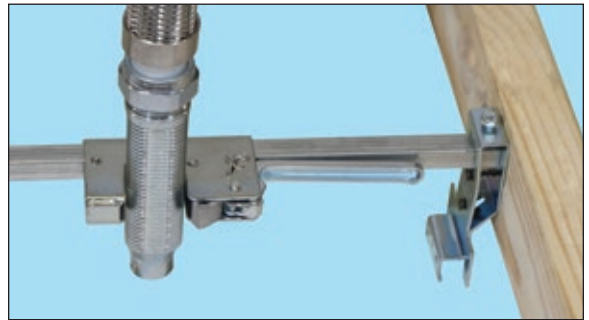

8. Place the outlet reducer into the center bracket, then adjust the height of the outlet reducer to the desired level and lock the reducer into place by closing the handle on the center bracket firmly until you hear click sound. While doing so, use other hand to hold the bar stock to minimize the movement caused by closing the handle.

NOTE: For wood beams larger than 2 x 4, longer sprinkler reducing nipples should be used or the alternative installation method below should be used.

ALTERNATIVE WOOD BEAM INSTALLATION INSTRUCTIONS (FM ONLY)

1. Perform steps 1 – 4 of the “Installation Instructions of Suspended Ceiling of T-Bar Grids” (see page 2).
2. Loosen bolt from the top of one side of side bracket assembly.
3. Measure the distance between the wood beams.
4. If the bar stock is longer than the distance between the two (2) wood beams, cut the bar stock to the length where it fits between the two (2) wood beams. The length must be measured from the inside of wood beam where the side bracket and the bar stock connected will rub against the surface of wood beam to the opposite surface of wood beam where the other side of side bracket and bar stock joint will rub against the surface of wood beam.

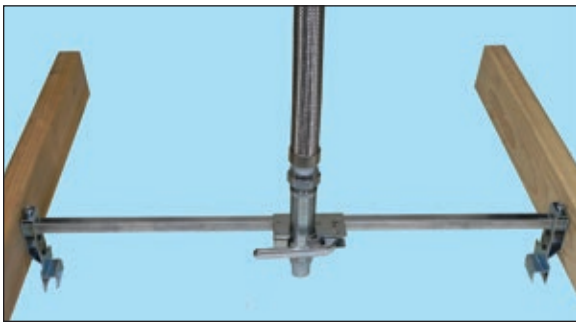

5. Once in place, secure the bracket assembly to the wood beam ceiling grid by using four (4), 2” long #8 self-drilling sheet metal screws through the holes provided on each side of bracket. On each side of side brackets, there are two (2) holes for self-drilling sheet metal screws. Make sure to use both holes to secure the side brackets firmly. Ensure that the sheet metal screws penetrated through the wood beam ceiling grid.

NOTE: Fix the top two (2) sheet metal screws first.

6. Tighten the bolt on top of the side bracket with a torque of 2.89 ft/lbs.
7. Position the center bracket to the desired location.



8. Place the outlet reducer into the center bracket, then adjust the height of the outlet reducer to the desired level and lock the reducer into place by closing the handle on the center bracket firmly until you hear the click sound. While doing so, use other hand to hold the bar stock to minimize the movement caused by closing the handle.

INSTALLATION INSTRUCTIONS OF SUSPENDED HAT CHANNEL CEILING GRIDS

1. Perform steps 1 – 4 of the “Installation Instructions of Suspended Ceiling of T-Bar Grids” (see page 2).
2. With an adjustable wrench, unscrew the wing screw and washer from one side of side bracket assembly.



3. Place both hat channel side brackets to the hat channel ceiling grids (install in accordance with ASTM C754 Standards). Be aware that the hat channel side brackets should engage with the hat channel ceiling grids. Once in place, tighten both wing screws located on top of each side bracket with an approximate torque of 36 inch-lbs, approximately 1/2 turn past hand tight.



4. Tighten the wing screws, M6 x 1-3/4” located at the bottom of each hat channel side bracket to an approximate torque of 40 inch-lbs, approximately 1/2 to 3/4 turn past hand tight.
5. Secure both hat channel side brackets into place by using #8 x 3/4” self-drilling screws and drilling them into the wings extended out from each hat channel side bracket. Ensure that the screws are drilled into and through the hat channel ceiling grids.

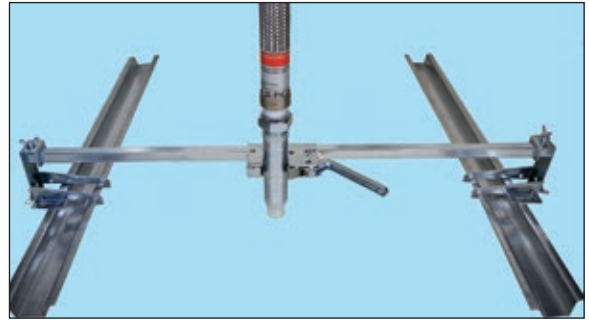

6. Position the center bracket to the desired location.

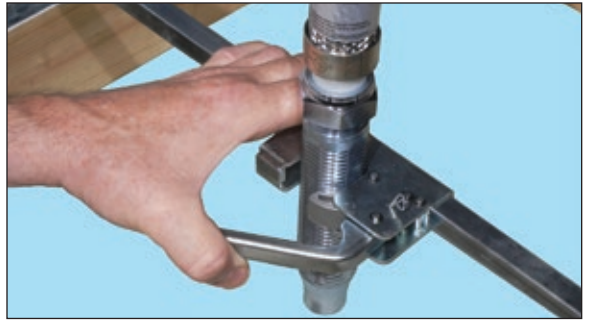

7. Place the outlet reducer into the center bracket, then adjust the height of the outlet reducer to the desired level and lock the reducer into place by closing the handle on the center bracket firmly until you hear click sound.